



USER'S MANUAL
MANUEL DE L'UTILISATEUR
MANUAL DEL USUARIO

EW32S5UW

TABLE OF CONTENTS

| | |
|---|----|
| TABLE OF CONTENTS..... | i |
| DIGITAL TELEVISION TRANSITION NOTICE | 1 |
| ENERGY STAR DISCLAIMER | 1 |
| IMPORTANT INFORMATION..... | 2 |
| Warnings | 2 |
| NOTICES | 3 |
| FCC COMPLIANCE STATEMENT | 4 |
| IMPORTANT SAFETY INSTRUCTIONS | 5 |
| Circuit Overload..... | 6 |
| Power Cord Protection | 6 |
| Ventilation..... | 6 |
| WARNINGS AND PRECAUTIONS | 7 |
| ANTENNA INSTALLATION SAFETY..... | 8 |
| Lightning..... | 8 |
| Power lines..... | 8 |
| CLEANING THE LED TV | 9 |
| Dolby-Digital Notice..... | 9 |
| Licensing and Patent Information..... | 9 |
| PACKAGE CONTENTS..... | 10 |
| CONTROL PANEL..... | 11 |
| TERMINALS | 12 |
| REMOTE CONTROL | 13 |
| REMOTE CONTROL OPERATION..... | 14 |
| INSTALLING THE REMOTE CONTROL BATTERIES | 14 |
| REMOTE CONTROL TRANSMISSION RANGE | 14 |
| LED TV BASE..... | 15 |
| INSTALLING THE LED TV BASE | 15 |
| REMOVING THE LED TV BASE | 16 |
| ANTENNA CONNECTION..... | 17 |
| OUTDOOR ANTENNA CONNECTION..... | 17 |
| CABLE TV (CTV/DTV) CONNECTION | 17 |
| EXTERNAL DEVICE CONNECTIONS | 18 |

TABLE OF CONTENTS

POWER CONNECTION 20
 CONNECTING AC POWER..... 20
 INITIAL SETUP 20
 CABLE OR SATELLITE BOX CONNECTION SETUP 21
 OTHER INPUT SOURCE CONNECTION SETUP 23
 ANTENNA OR COACIAL CABLE INPUT CONNECTION
 SETUP SETUP 25
BASIC OPERATIONS..... 27
 TURNING THE POWER ON AND OFF 27
 ADJUSTING THE VOLUME..... 27
 CHANGING CHANNELS 28
 SELECTING THE INPUT SOURCE..... 28
 ADJUSTING THE DISPLAY FORMAT 29
SETUP MENUS 30
 SETUP MENU OPERATION..... 30
 PICTURE..... 31
 SOUND 38
 CHANNEL 42
 PARENTAL CONTROL..... 45
 SETUP 50
 OTHERS 54
WALL MOUNT OPTION 55
 WALL MOUNT INSTALLATION REMINDERS 55
TROUBLESHOOTING 56
SPECIFICATIONS 59

DIGITAL TELEVISION TRANSITION NOTICE

This device contains a digital television tuner, so it should receive digital over the air TV programming, with a suitable antenna, after the end of full-power analog TV broadcasting in the United States on June 12, 2009. The nationwide switch to digital television broadcasting will be complete on June 12, 2009, but your local television stations may switch sooner. After the switch, analog-only television sets that receive TV programming through an antenna will need a converter box to continue to receive over-the-air TV. Watch your local stations to find out when they will turn off their analog signal and switch to digital-only broadcasting.

For more information, call the FCC at 1-888-CALL-FCC (1-888-225-5322) or see www.DTV.gov. For information on the TV Converter program, and on government coupons that may be used toward the purchase of one, see www.dtv2009.gov, or call the NTIA at 1-888-DTV-2009.

ENERGY STAR DISCLAIMER

This Westinghouse product has earned the ENERGY STAR® for meeting U.S. Federal energy efficiency guidelines as set by the Department of Energy and Environmental Protection agency. The ENERGY STAR® program exists to provide energy saving guidelines and help promote energy efficient products and practices. Changes to certain features, settings and functions of this TV can change and/or increase its power consumption. Depending on how settings are changed, power consumption may exceed the limits required for ENERGY STAR® qualification. This Westinghouse TV will operate at optimal energy efficiency in “Home” mode.

IMPORTANT INFORMATION

Warnings

To reduce the risk of fire or electric shock:

- Do not expose this product to rain or moisture.
- Do not remove the rear cover. There are no user-serviceable parts inside. Refer all servicing requirements to qualified service personnel.
- The plug should be connected to a mains socket outlet with a protective earthing connection.



The lightning flash with arrowhead inside an equilateral triangle symbol is intended to alert the user to the presence of uninsulated dangerous voltage within the product's enclosure that may be of sufficient magnitude to constitute a risk of electric shock.



The exclamation inside an equilateral triangle symbol is intended to alert the user to related operating and maintenance instructions in the user documentation accompanying the product.

WARNING!

This device must be operated with the original power supply.

WARNING!

To prevent injury, this apparatus must be securely attached to the floor/wall in accordance with the installation instructions.

CAUTION:

The power supply outlet should be located near the LED TV and should be easily accessible.

Always use the appropriate AC cord that is certified for your specific country. Some examples are listed below:

- USA – UL
- Canada – CSA
- Japan – Electric Appliance Control Act

NOTICES

Important Notices Concerning Power Cord Selection

The specific power cord for this LED TV is enclosed and has been selected according to the country of destination. Use the enclosed power cord to prevent electric shock. Observe the following guidelines if it is necessary to replace the original cord set, or if there is no cord set enclosed. The female receptacle of the cord set must meet IEC-60320 requirements and should look like Figure A1 below:

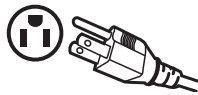

Figure A2

For the United States and Canada

In the United States and Canada the male plug is a NEMA5-15 style (Figure A2), UL-listed, and CSA-labeled. For LED TVs that are to be placed on a desk or table, type SVT or SJT cord sets may be used. For LED TVs that are to be placed directly on the floor, only SJT type cord sets may be used. The cord set must be selected according to the current rating for the LED TV. Consult the table below for the selection criteria of power cords used in the United States and Canada.

| Cord Type | Size of Conductor in Cord | Maximum Unit Current Rating |
|-----------|---------------------------|-----------------------------|
| SJT | 18 AWG | 10 Amps |
| | 16 AWG | 12 Amps |
| | 14 AWG | 12 Amps |
| SVT | 18 AWG | 10 Amps |
| | 17 AWG | 12 Amps |

FCC COMPLIANCE STATEMENT

This equipment has been tested and complies with the limits for a Class B digital device, pursuant to part 15 of the FCC Rules. These limits are designed to provide reasonable protection against harmful interference in a residential installation. This equipment generates, uses, and can radiate radio frequency energy, and may cause harmful interference to radio communications if not installed and used in accordance with the instructions. However, there is no guarantee that interference will not occur in a particular installation. If this equipment does cause harmful interference to radio or television reception, which can be determined by turning the equipment off and on, the user is encouraged to try to correct the interference by one or more of the following measures:

- Reorient or relocate the receiving antenna.
- Increase the distance between the LED TV and the receiver.
- Connect the LED TV to an outlet on a circuit separate from to which the receiver is connected.
- If the interference persists even after performing the above measures, consult the Westinghouse Service Center or an experienced radio/TV technician for assistance.

FCC Warning

To assure continued FCC compliance, use a grounded power supply cord and the provided shielded video interface cable with bonded ferrite cores. If a BNC cable is used, use only a shielded BNC (5) cable. Also, any unauthorized changes or modifications not expressly approved by the manufacturer will void the user's authority to operate this device.

IMPORTANT SAFETY INSTRUCTIONS

Make sure to note and follow all warnings and instructions marked on the LED TV. Observe the following safety instructions.

- Read these instructions.
- Keep these instructions.
- Heed all warnings.
- Follow all instructions.
- Do not use this apparatus near water.
- Clean only with dry cloth.
- Do not block any ventilation openings. Install in accordance with the manufacturer's instructions.
- Do not install near any heat sources such as radiators, heat registers, stoves, or other apparatus (including amplifiers) that produce heat.
- Do not defeat the safety purpose of the polarized or grounding-type plug. A polarized plug has two blades with one wider than the other. A grounding type plug has two blades and a third grounding prong. The wide blade or the third prong are provided for your safety. If the provided plug does not fit into your outlet, consult an electrician for replacement of the obsolete outlet.
- Protect the power cord from being walked on or pinched particularly at plugs, convenience receptacles, and the point where they exit from the apparatus.
- Only use attachments/accessories specified by the manufacturer.
- Use only with the cart, stand, tripod, bracket, or table specified by the manufacturer, or sold with the apparatus. When a cart is used, use caution when moving the cart/apparatus combination to avoid injury from tip-over.



- Unplug this apparatus during lightning storms or when unused for long periods of time.
- Refer all servicing to qualified service personnel. Servicing is required when the apparatus has been damaged in any way, such as power-supply cord or plug is damaged, liquid has been spilled or objects have fallen into the apparatus, the apparatus has been exposed to rain or moisture, does not operate normally, or has been dropped.

IMPORTANT INFORMATION

Circuit Overload

Do not overload wall outlets, extension cords, or power strips. This can result in a fire or electronic shock.

Power Cord Protection

Power supply cords should be routed so that they are not likely to be walked on or pinched by items placed upon or against them. Periodically inspect the cords for damage. Install the LED TV near a wall socket outlet where the power cord can be readily accessed.

Ventilation

The slots and openings on the cabinet are provided for necessary ventilation. To ensure reliable operation of the LED TV and to protect it from overheating, these slots and openings must never be blocked or covered.



Never cover the slots and openings with a cloth or other materials.

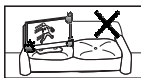

Do not block the openings by placing the LED TV on a bed, sofa, rug or other similar surface.



Do not place the LED TV in a built-in installation such as a bookcase or a rack unless proper ventilation is provided or the manufacturer's instructions have been adhered to.

WARNINGS AND PRECAUTIONS

- Do not orient the LED TV towards direct sunlight to reduce glare.
- If the LED TV will not be used for a long period of time, unplug the unit and remove the batteries from the remote control.
- Avoid touching the display screen by hand or any object.
- Never remove the rear cover. The LED TV interior contains high-voltage parts. You may be seriously injured if you touch them.
- Always handle the LED TV with caution when moving it.
- Do not install the LED TV in airtight compartments, or in areas where it can be exposed to water or high temperature.
- Ensure that the area around the LED TV is clean and free of moisture.
- Do not place anything on the LED TV that can hinder heat dissipation.
- Do not place naked flame sources, such as lighted candles, on or near the LED TV.
- Do not place anything on the LED TV that can cause liquid to splash on it (e.g. flower vase).
- Do not place heavy objects on the LED TV, audio/video cables, or power cord.
- If the LED TV emits smoke, abnormal noise, or a strange odor, immediately turn it off and contact the Westinghouse Service Center by:
 - Logging on to www.wde.com.
 - Contacting the Westinghouse Customer Service at (800) 701-0680.
 - E-mailing us at service@wde.com.

ANTENNA INSTALLATION SAFETY

Outdoor Antenna Grounding

If an outside antenna or cable system is connected to the LED TV, be sure the antenna or cable system is grounded to prevent voltage surges and built-up static charges. Article 810 of the National Electrical Code, ANS/NFPA 70, provides information on proper grounding of the mast and supporting structure, grounding of the lead-in wire to an antenna discharge unit, connection to grounding electrodes, and requirements for the grounding electrode.

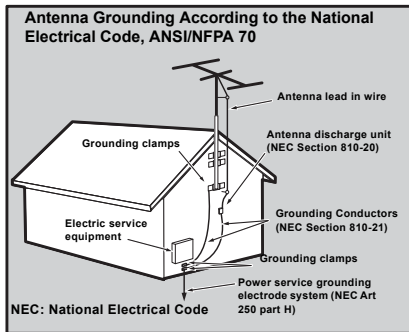

Lightning

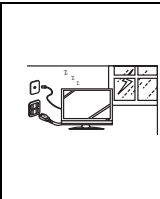

For added protection for the LED TV during a lightning storm, or when it is left unattended and unused for long periods of time, unplug it from the wall outlet and disconnect the antenna or cable system. **DO NOT** disconnect the antenna or the power cord during a heavy storm—lightning may strike while you are holding the cable cord, causing serious injury. Turn off the LED TV and wait for the weather to improve.

Power lines

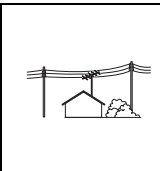

An outside antenna system should not be located in the vicinity of overhead power lines or other electric light or power circuits, or where it can fall into such power lines or circuits. When installing an outside antenna system, extreme care should be taken to keep from touching such power lines or circuits as contact with them might be fatal.

CLEANING THE LED TV



- Make sure the LED TV is turned off and the power cord is disconnected from the power outlet.
- Never spray or pour any liquid directly onto the screen or the case.

To clean the screen:

- 1 Wipe the screen with a clean, soft, lint-free cloth. This removes dust and other particles.
- 2 If it is still not clean, apply a small amount of non-ammonia, non-alcohol based glass cleaner onto a clean, soft, lint-free cloth, and wipe the screen.

To clean the case:

- 1 Wipe the case with a soft, dry cloth.
- 2 If it is still not clean, apply a small amount of non-ammonia, non-alcohol based, mild non-abrasive detergent onto a clean, soft, lint-free cloth, then wipe the surface.

Dolby-Digital Notice







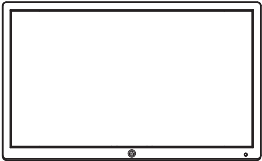

Manufactured under license from Dolby Laboratories. Dolby and the double-D symbol are registered trademarks of Dolby Laboratories.

Licensing and Patent Information

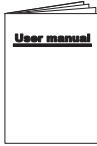
This WESTINGHOUSE product may be covered by one or more U.S. and foreign patents and patent applications. See <http://westinghousedigital.com/compliance/> for details.

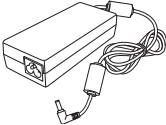
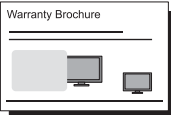
PACKAGE CONTENTS

| | |
|--|---|
| <p>32" LED TV Unit</p> | <p>Remote Control (with 2x AAA batteries)</p> |
|  |  |
| <p>LED TV Base</p> | <p>User Manual</p> |
|  |  |
| <p>Power Cord</p> | <p>Warranty Card</p> |
|  |  |
| <p>AC Adapter</p> | <p>Warranty Brochure</p> |
|  |  |
| <p>Screws for Base</p> | |
| <p>M4x18 *2pcs</p>  <p>Cover neck</p> | |

CONTROL PANEL

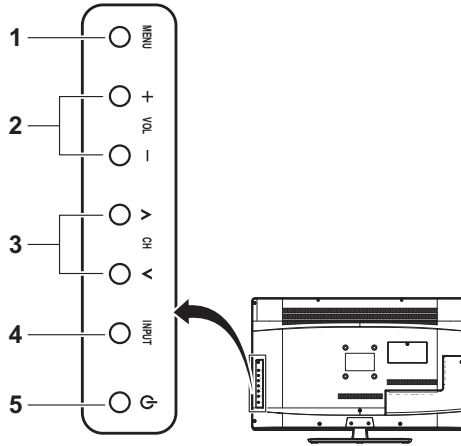

| Item | Description |
|----------------|--|
| 1. MENU | Displays the LED TV setup screen. |
| 2. Volume +/- | <ul style="list-style-type: none"> Adjusts the volume during playback. Selects an item on a menu screen. |
| 3. Channel +/- | <ul style="list-style-type: none"> Switches the channel during TV viewing. Selects an item on a menu screen. |
| 4. INPUT | <ul style="list-style-type: none"> Selects the video input source. Executes a command on a menu screen. |
| 5. Power | Toggles the power on and off. |

TERMINALS

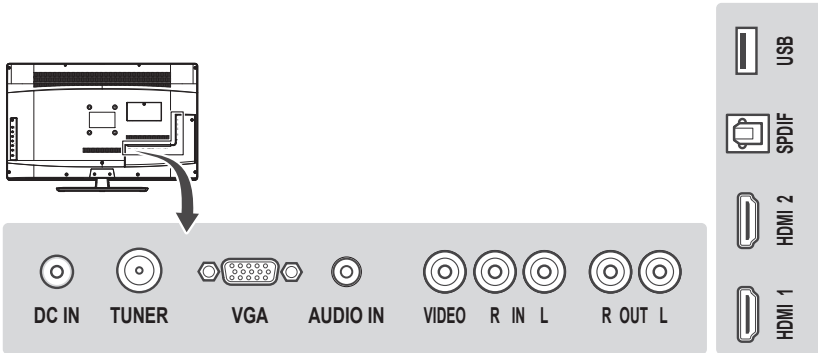

| Item | Function |
|-----------------------|---|
| 1. DC in | Connects the AC to DC adapter from this outlet to a power source. |
| 2. Audio in | Connects to the audio out port of a computer. |
| 3. VGA | Connects to a computer or other device with a VGA output using a 15-pin VGA cable. |
| 4. Composite AV input | Connect to an external AV device such as a VCR, DVD player, set-top box, or game system. |
| 5. TV tuner | Connects the LED TV to an antenna or cable service. |
| 6. Audio out | Connect to an analog audio output device. |
| 7. HDMI 1/2 | Connects to an external AV device such as a VCR, DVD player, set-top box, or game system. |
| 8. USB Service port | For service only. |
| 9. SPDIF audio out | Connects to an external digital audio receiver. |

REMOTE CONTROL

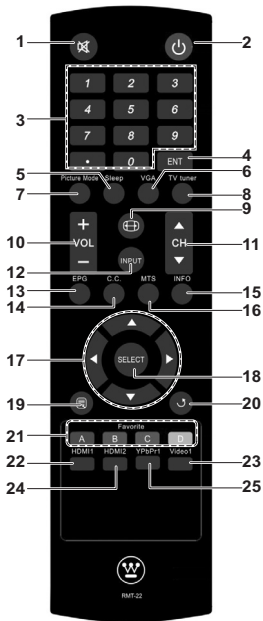

| Item | Description |
|---------------------|---|
| 1. Mute | Mutes the sound. Press again to toggle the sound back on. |
| 2. Power | Toggles the TV power on or off. |
| 3. Channel keys | Use to key in the channel number. |
| 4. Enter ENT | Executes a channel entry. |
| 5. Sleep | Sets the sleep timer for the LED TV to turn off automatically. |
| 6. VGA | Switches to the VGA input source. |
| 7. Picture Mode | Selects a preset viewing options. |
| 8. TV tuner | Switches to the TV input source. |
| 9. Aspect ratio | Selects the video display format. |
| 10. Vol +/- | Ajusts the system volume. |
| 11. Ch ▲ / ▼ | Switches to other TV channels. |
| 12. Input | Selects the video input source. |
| 13. EPG | Displays the Electronic Program Guide (EPG). It contains the program information for the channel you're watching. |
| 14. CC | Toggles the closed caption display on or off. |
| 15. Info | Displays the input source or channel information as well as the system time. |
| 16. MTS | Toggles the Multichannel Television Sound options. |
| 17. Arrow keys | Navigate through the on-screen menus. |
| 18. Select | Confirms the selection. |
| 19. Menu | Accesses the LED TV setup menus. |
| 20. Return | Switches to the last selected channel. |
| 21. Favorite | Switches to the favorite channels (for details on how to save a new favorite channel, see page 28). |
| 22. HDMI1 | Selects HDMI1 as the input source. |
| 23. HDMI2 | Selects HDMI2 as the input source |
| 24. YPbPr1 | Selects VGA-Component as the input source. |
| 25. Video1 | Selects the Composite AV device as the input source. |

REMOTE CONTROL OPERATION

INSTALLING THE REMOTE CONTROL BATTERIES

CAUTIONS:

- Only use AAA batteries.
- Do not mix new and old batteries. This may result in cracking or leakage, which may pose a fire risk or lead to personal injury.
- Insert batteries according to the (+) and (-) markings. Inserting the batteries incorrectly may result in cracking or leakage, which may pose a risk of fire or lead to physical injury.
- Dispose of used batteries in accordance with local laws and regulations.
- Keep batteries away from children and pets.
- When the remote control will not to be used for an extended period, remove the batteries.

- 1 Remove the battery cover.
- 2 Insert the batteries. Make sure the (+) and (-) marks on the batteries match those inside the compartment.
- 3 Re-attach the battery cover.



REMOTE CONTROL TRANSMISSION RANGE

Transmission range depends upon the reception angle. The range of coverage is 20° horizontal/vertical at a distance of 10 feet from the LED TV.

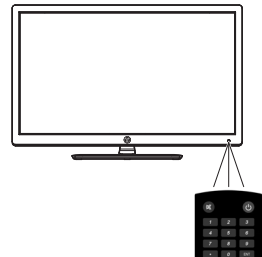

LED TV BASE

CAUTION:

The LED TV unit may be too heavy for one person to lift. If this is the case, make sure to ask for assistance in handling the LED TV to prevent physical injury and/or damage to the unit.

INSTALLING THE LED TV BASE

- 1 Open the LED TV carton box.
- 2 Remove the LED TV base.
- 3 Remove the plastic bag.
- 4 Remove the two top carton stabilizers from the LED TV.
- 5 Remove the protective plastic covering the LED TV.
- 6 Grasp the two sides of the LED TV and then pull it out of the carton box.
- 7 Remove the two bottom carton stabilizers from the LED TV.
- 8 Lay the LED TV on a clear, flat, and stable surface.
- 9 Align the base to the bottom side of the LED TV and use four M4 x 18 screws to secure it.

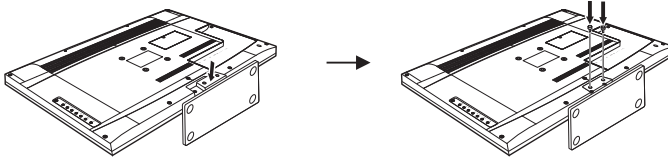

- 10 Carefully orient the LED TV in an upright position.

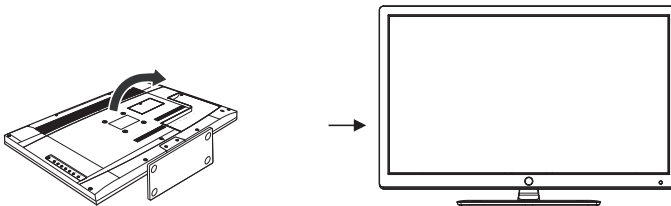

- 11 Use one M5 x 16 screw to fix the stand base and LED TV on the desk.

REMOVING THE LED TV BASE

If you intend to repack the LED TV unit (for shipping or storage) or you want to change the installation to a wall mount option, you must first remove the LED TV base.

- 1 Turn off the LED TV and all connected devices.
- 2 Disconnect the power cord from the LED TV.
- 3 Disconnect all signal cables from the I/O port terminals.
- 4 Remove the M5 x 16 screw securing the base to the desk.
- 5 Lay the LED TV on a clear, flat, and stable surface.

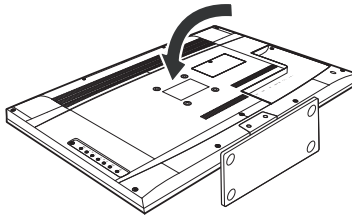

- 6 Remove the screws securing the base to the LED TV.
- 7 Detach the base from LED TV.

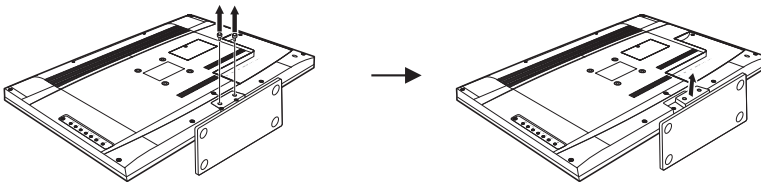

- 8 Pack the screws you removed in step 5 together with the LED TV base for future reassembly.

ANTENNA CONNECTION

OUTDOOR ANTENNA CONNECTION

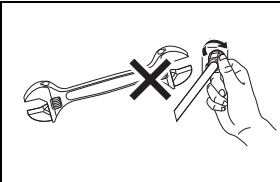
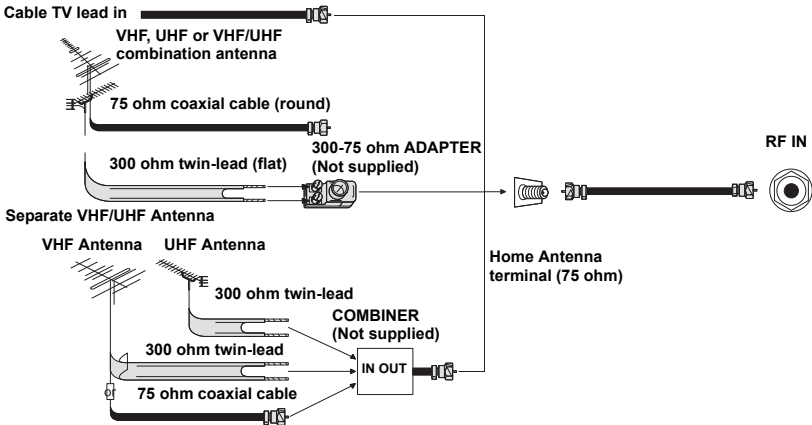

NOTE:

The F-type connector should be finger-tightened only. When connecting the RF cable to the LED TV, do not tighten F-type connector with any tool. If tools are used, it may cause damage to the LED TV (e.g. breaking of internal circuit).

CABLE TV (CTV/DTV) CONNECTION

The unit has a TV tuner (75 ohm coaxial cable connector) located on the rear I/O panel for easy cable hookup. When connecting the 75 ohm coaxial cable to the unit, screw the 75 ohm cable to the TV tuner. Some cable TV companies offer premium pay channels. Since the signals of these channels are scrambled, a cable TV converter/descrambler is usually provided to the subscriber by the cable TV company. This converter/descrambler is necessary for normal viewing of the scrambled channels. (Set your TV to channel 3 or 4. Typically one of these channels is used. If a channel is unknown, consult your cable TV company.) For more specific instructions on installing cable TV, consult your cable TV company. One possible method of utilizing the converter/descrambler provided by your cable TV company is explained below.

EXTERNAL DEVICE CONNECTIONS

- A position on the RF switch (not supplied) – You can view all unscrambled channels by using the TV's channel keys.
- B position on the RF switch (not supplied) – You can view the scrambled channels via the converter/descrambler by using the converter's channel keys.

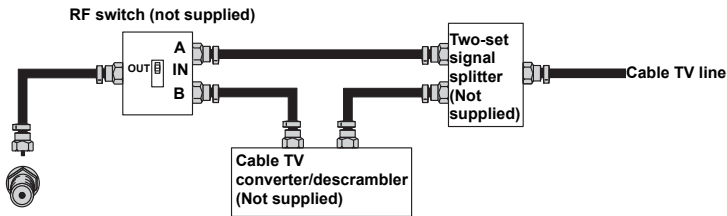

EXTERNAL DEVICE CONNECTIONS

IMPORTANT:

- Turn off the LED TV first before connecting an external device to prevent any possible damage or physical injury.
- For more information about external device connections, see the operation manual of the external device you wish to connect to the LED TV.
- Make sure that the correct cables are connected to each terminal. Improper cable connections may cause damage to the LED TV.

You can enjoy picture and sound by connecting various audio-video devices to the terminals located on the rear and side I/O panels of the LED TV.

- TV cable input – You can use a commercially available audio/video cable.
- Component (YPbPr) input – Picture can be displayed only when a 480i, 480P, 720P, 1080i, or 1080P signal is received.
- HDMI input – Picture can be displayed only when a 480i, 480P, 720P, 1080i, or 1080P signal is received. When you connect to the HDMI terminal with a DVI-HDMI conversion cable, there is a possibility that the picture may not display correctly.
- Audio output – You can output audio signals from the LED TV set through the analog audio out and SPDIF terminals.

The following diagram shows the external device connections.

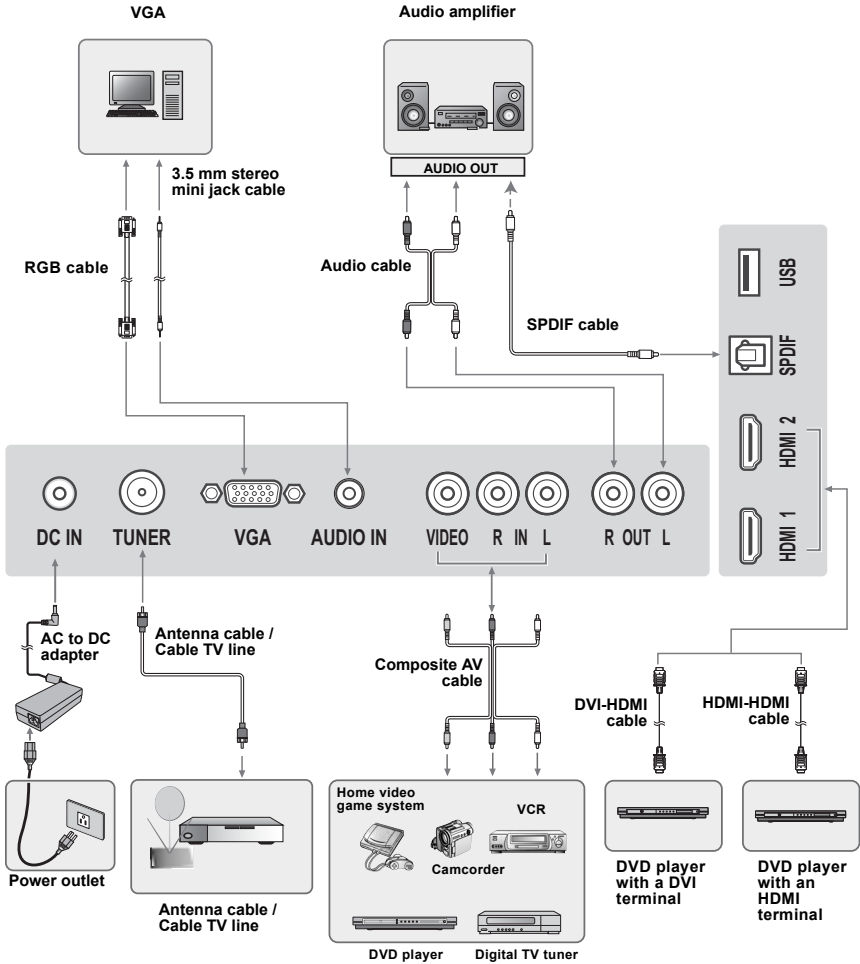

POWER CONNECTION

CONNECTING AC POWER

IMPORTANT:

The LED TV is designed to be powered via an AC adapter. Use **ONLY** the AC adapter included in the package. Turn off all connected devices before plugging the AC adapter into the power outlet.

Connect the power cord of the AC adapter to the LED TV then to a proper AC outlet.

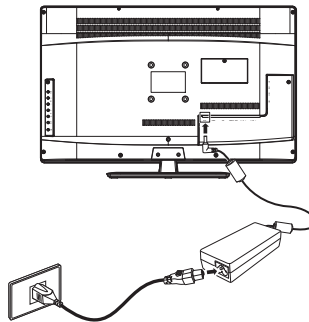

INITIAL SETUP

Press  on the control panel or on the remote control to turn on the LED TV. Select the desired language and select **Yes** to use the SetupWizard. The SetupWizard will guide you on how to set up the LED TV's operational settings.

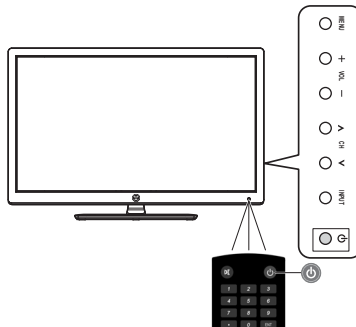

CABLE OR SATELLITE BOX CONNECTION SETUP

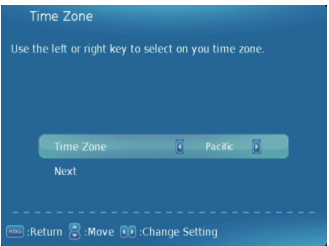
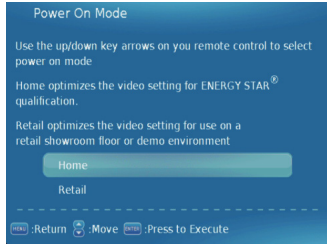
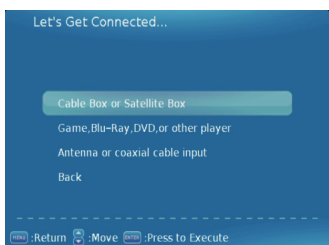
| | |
|--|--|
|  <p>Select Language</p> <p>Follow this guide to help you set up your TV. Use the Up and Down arrows on your remote control and select the Language you want to use for menus and message screens.</p> <p>English Enter</p> <p>French Enter</p> <p>Spanish Enter</p> <p>← Move → Press to Execute</p> | <p>Select Language</p> <p>Use the up and down arrows on your HDTV control panel or remote control to select the language to be used for menus and messages. Press SELECT to continue.</p> |
|  <p>Time Zone</p> <p>Use the left or right key to select on you time zone.</p> <p>Time Zone Pacific</p> <p>Next</p> <p>← Return → Move → Change Setting</p> | <p>Time Zone</p> <p>Use the up and down arrows on your HDTV control panel or remote control to select your local time zone. Press SELECT to continue. Press Go Back to return to the previous screen.</p> |
|  <p>Power On Mode</p> <p>Use the up/down key arrows on you remote control to select power on mode</p> <p>Home optimizes the video setting for ENERGY STAR® qualification.</p> <p>Retail optimizes the video setting for use on a retail showroom floor or demo environment</p> <p>Home</p> <p>Retail</p> <p>← Return → Move → Press to Execute</p> | <p>Power On Mode</p> <p>Use the up and down arrows on your HDTV control panel or remote control to select the power on mode. Press SELECT to continue. Press Go Back to return to the previous screen.</p> |
|  <p>Let's Get Connected...</p> <p>Cable Box or Satellite Box</p> <p>Game, Blu-Ray, DVD, or other player</p> <p>Antenna or coaxial cable input</p> <p>Back</p> <p>← Return → Move → Press to Execute</p> | <p>Channel Scan - Cable/Satellite Box</p> <p>Select "Click here to connect a Cable Box or Satellite Box." and press SELECT on your remote control to start scanning channels. Press SELECT to continue. Press Go Back to return to the previous screen.</p> |

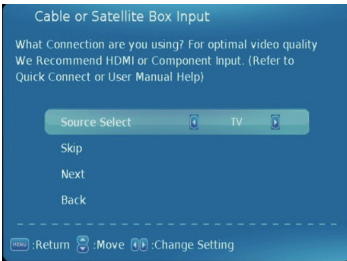

Cable/Satellite Box Input

Use the up and down arrows on your HDTV control panel or remote control to select the input connected to the set top box. Press SELECT to continue. Press Go Back to return to the previous screen.

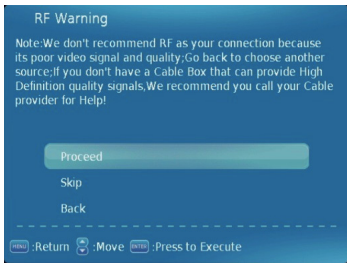

RF Warning

Use the up and down arrows on your HDTV control panel or remote control to select. Select "Proceed" and then press SELECT to search the program. Press Go Back to return to the previous screen.

OTHER INPUT SOURCE CONNECTION SETUP

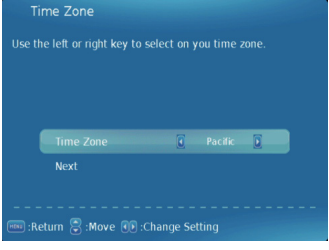
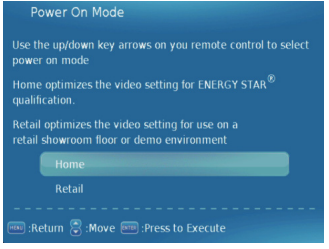
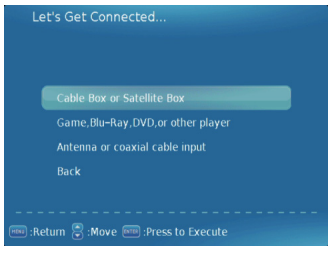
| | |
|---|---|
|  <p>Select Language</p> <p>Follow this guide to help you set up your TV. Use the Up and Down arrows on your remote control and select the Language you want to use for menus and message screens.</p> <p>English Enter</p> <p>French Enter</p> <p>Spanish Enter</p> <p>← Move → Press to Execute</p> | <p>Select Language</p> <p>Use the up and down arrows on your HDTV control panel or remote control to select the language to be used for menus and messages. Press SELECT to continue.</p> |
|  <p>Time Zone</p> <p>Use the left or right key to select on you time zone.</p> <p>Time Zone Pacific</p> <p>Next</p> <p>← Return → Move → Change Setting</p> | <p>Time Zone</p> <p>Use the up and down arrows on your HDTV control panel or remote control to select your local time zone. Press SELECT to continue. Press Go Back to return to the previous screen.</p> |
|  <p>Power On Mode</p> <p>Use the up/down key arrows on you remote control to select power on mode</p> <p>Home optimizes the video setting for ENERGY STAR[®] qualification.</p> <p>Retail optimizes the video setting for use on a retail showroom floor or demo environment</p> <p>Home</p> <p>Retail</p> <p>← Return → Move → Press to Execute</p> | <p>Power On Mode</p> <p>Use the up and down arrows on your HDTV control panel or remote control to select the power on mode. Press SELECT to continue. Press Go Back to return to the previous screen.</p> |
|  <p>Let's Get Connected...</p> <p>Cable Box or Satellite Box</p> <p>Game, Blu-Ray, DVD, or other player</p> <p>Antenna or coaxial cable input</p> <p>Back</p> <p>← Return → Move → Press to Execute</p> | <p>Let's Get Connected</p> <p>Select "Click here to connect a Game, Blu-Ray, DVD, or other player." and press SELECT on your remote control. Press SELECT to continue. Press Go Back to return to the previous screen.</p> |

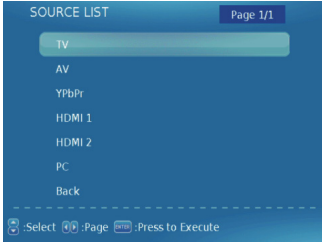

Select Input Source

Use the up and down arrows on your HDTV control panel or remote control to select the input source. Press SELECT to continue. Press Go Back to return to the previous screen.

ANTENNA OR COACIAL CABLE INPUT CONNECTION SETUP

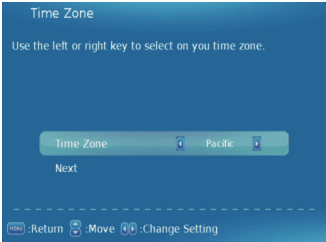
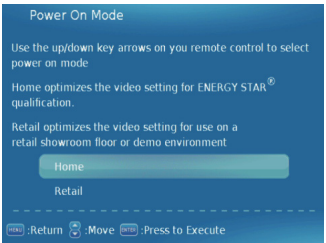
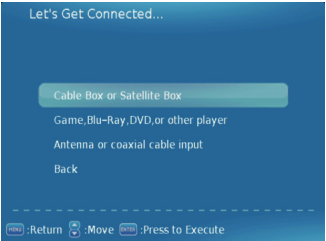
| | |
|---|--|
|  | <p>Select Language</p> <p>Use the up and down arrows on your HDTV control panel or remote control to select the language to be used for menus and messages. Press SELECT to continue.</p> |
|  | <p>Time Zone</p> <p>Use the up and down arrows on your HDTV control panel or remote control to select your local time zone. Press SELECT to continue. Press Go Back to return to the previous screen.</p> |
|  | <p>Power On Mode</p> <p>Use the up and down arrows on your HDTV control panel or remote control to select the power on mode. Press SELECT to continue. Press Go Back to return to the previous screen.</p> |
|  | <p>Let's Get Connected</p> <p>Select "Click here to scan channels from the Antenna or coaxial cable input." and press SELECT on your remote control to start scanning channels. Press SELECT to continue. Press Go Back to return to the previous screen.</p> |

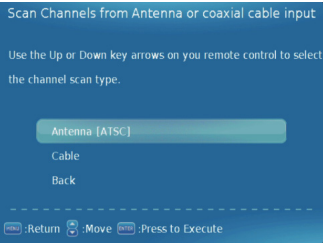
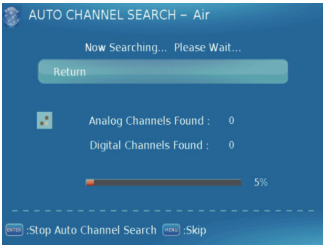
| | |
|---|--|
|  | <p>Select Channel Scan Type</p> <p>Use the up and down arrows on your HDTV control panel or remote control to select the channel scan type. Press SELECT to continue. Press Go Back to return to the previous screen.</p> |
|  | <p>Channel Scan in progress</p> <p>The channel scan may take a while to complete. When the scan is complete, you will be able to watch your local TV programming.</p> |

BASIC OPERATIONS

TURNING THE POWER ON AND OFF

Turning on the power

Press  on the control panel or on the remote control to turn on the LED TV.

Turning off the power

Press  on the control panel or on the remote control to turn off the LED TV. The LED behavior will depend on the enabled Power settings.

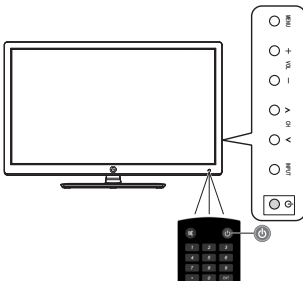

| LED indicator | Operation |
|-------------------------|---------------------|
| Turns from none to red. | Turn the power on. |
| Turns from red to none. | Turn the power off. |

NOTES:

- If you are not going to use the TV for a long time, be sure to disconnect the power cord from the wall outlet and remove the batteries from the remote control.
- In standby mode, a small amount of electricity is still consumed even when the power is turned off.

ADJUSTING THE VOLUME

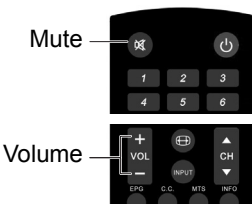

Volume

Press **Vol+** to increase the volume; press **Vol-** to decrease the volume.

Mute

Press  to turn off the sound. The mute icon appears on the screen. Press again to turn on the sound.

CHANGING CHANNELS

Follow the instructions below to change channels.

Using the Ch ▲ / ▼ Buttons

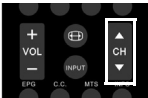

Browse channels

To browse through the available channels, press **Ch ▲ / ▼** on the remote control or on the control panel.

Using the Channel Keys



Selecting channel

To change to a certain channel, key in the channel number using the channel keys and press **ENT**.

Selecting digital channel

To select a digital channel, key in the digital channel number using the channel keys and the • key, then press **ENT**.

Using the Favorite Keys



Selecting favorite channels

To select a favorite channel, press the **Favorite** button (A, B, C, or D) corresponding to the preferred channel.

Saving a channel as a favorite

- 1 Switch to the channel you want to add as a favorite.
- 2 Press and hold the **Favorite** button which you want to add the current channel to for 3 seconds.
- 3 The Channel Saved message appears to confirm the new favorite channel item.

SELECTING THE INPUT SOURCE

There are two ways to select the video input source.

Using the Individual Input Keys



TV, VGA, Video, YPbPr, HDMI Keys

Press any of the following remote control keys to change the input source: **TV, VGA, Video1, YPbPr1, HDMI1, or HDMI2**.

Using the Input Key

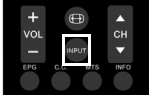

Select source using Input Key

- 1 Press **Input**.
- 2 A list of supported video sources is displayed.
- 3 Press ◀ / ▶ to select the preferred source.
- 4 Press  to switch to the selected input source.

ADJUSTING THE DISPLAY FORMAT

The input source can sometimes affect the way images are displayed on-screen. You can adjust the display format to view the image properly.

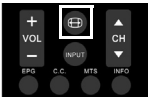

Format Options

Press  repeatedly to toggle the display format. As you toggle each option on, the actual display will change accordingly. The available options are:

- **Standard**: Picture is displayed in its original size.
- **Fill**: Picture is displayed to cover the entire screen.
- **Overscan**: Picture is scaled up to fit the display area.

SETUP MENUS

SETUP MENU OPERATION

Use the setup menus to configure the various operational settings of the LED TV.



Displaying the setup menu screen

Press  on the remote control or **MENU** on the control panel to display the setup menu screen.

Navigating the setup menu screen

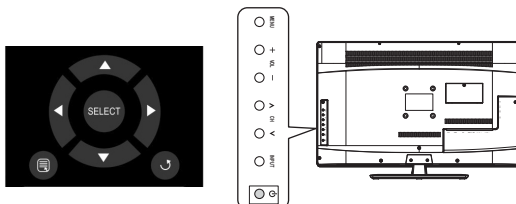
Use the buttons on the remote control or on the control panel to navigate through the menu screens.



| Action | Remote Control | Control Panel |
|--|---|-------------------------------|
| Displays or closes the menu bar. |  | MENU |
| <ul style="list-style-type: none"> Select and display a primary menu. Adjust sub-menu options. | ◀ / ▶ then INPUT | Volume +/- then INPUT |
| <ul style="list-style-type: none"> Select and display a sub-menu. Select a sub-menu or a sub-menu option. | ▲ / ▼ then INPUT | Channel +/- then INPUT |
| <ul style="list-style-type: none"> Returns to the primary menu tab from a sub-menu screen. Returns to the previous screen. |  | MENU |
| Applies the selected menu setting. | INPUT | INPUT |

PICTURE

Use the Picture sub-menus to configure the display quality.

Press  on the remote control or **MENU** on the control panel to display the setup menu screen then select **Picture** to display the Picture sub-menu. The following options are available: Picture Settings, Screen Size, VGA Settings, Color temperature, Advanced Picture Settings.

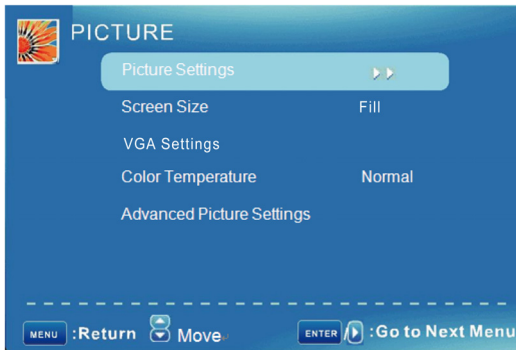

Picture Settings

Adjust the picture quality including brightness, contrast, color, tint, sharpness.

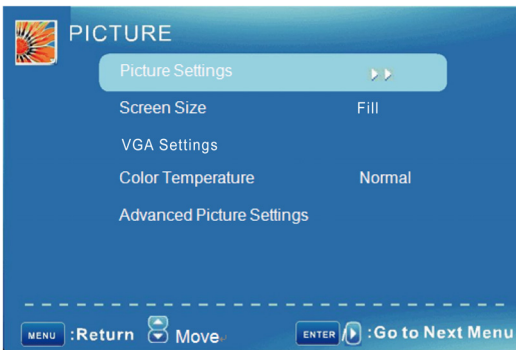

Picture mode

Use this sub-menu to select one of four preset view options optimized for different viewing conditions.

The following options are available:



- **Standard:** Select for standard picture.
- **Movie:** Select for a finely detailed picture.
- **User:** Select for standard picture.
- **Dynamic:** Select for enhanced picture contrast and sharpness.

Brightness

Use Brightness to adjust the luminance level.

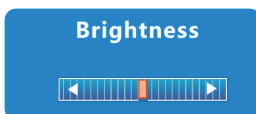
Adjusting Brightness





- 1 Use the ◀ / ▶ keys to select **Brightness** and press .
- 2 Press the ◀ / ▶ keys on the remote control to adjust the brightness level.
- 3 Press  to save and exit the screen.

Contrast

Use Contrast to adjust the brightness to darkness ratio.

Adjusting Contrast





- 1 Use the ◀ / ▶ keys to select **Contrast** and press .
- 2 Press the ◀ / ▶ keys on the remote control to adjust the contrast level.
- 3 Press  to save and exit the screen.

Color

Use Color to adjust the color intensity.

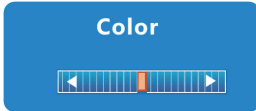
Adjusting Color



- 1 Use the ◀ / ▶ keys to select **Color** and press .
- 2 Press the ◀ / ▶ keys on the remote control to adjust the Color level.
- 3 Press  to save and exit the screen.



Tint

Use Hue to adjust the balance of the red, green, and blue colors in the display.

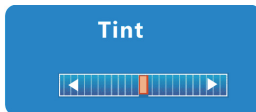
Adjusting Tint



The following options are available:

- 1 Use the ◀ / ▶ keys to select **Tint** and press .
- 2 Press the ◀ / ▶ keys on the remote control to adjust the Tint level.
- 3 Press  to save and exit the screen.

Sharpness

Use Sharpness to adjust the sharpness or softness of the display.

Adjusting Sharpness



- 1 Use the ◀ / ▶ keys to select **Sharpness** and press .

- 2 Press the ◀ / ▶ keys on the remote control to adjust the sharpness level.
- 3 Press  to save and exit the screen.

Screen Size

Press ◀ / ▶ to select the display aspect ratio till the picture is fit onto the screen. The options are different according to different input source.

VGA source

Two settings are available:



- **Wide:** Use to watch wide size content.
- **Dot by Dot:** means NOT any scaling to original input pixels size.

AV/YPbPr/HDMI/TV

Four settings are available:

- **Normal:** suitable to watch common TV program.
- **Wide:** do horizontal scaling on the wide panel.
- **Cinema:** for the 2.39:1 (perhaps marked as 2.40:1 on the disc) film.
- **Zoom:** suitable to view the analog TV which has wide(16:9) content on the 16:9 panel.

Adjusting Screen Size

- 1 Use the ◀ / ▶ keys to select **Screen Size** and press .
- 2 Press the ◀ / ▶ keys on the remote control to select the desired option.
- 3 Press  to save and exit the screen.

VGA Settings

VGA Settings Menu is available only in VGA DB15 or DVI mode. When DVI signal input, only Horizontal Position and Vertical Position can be adjusted.

Press ▲ / ▼ to highlight one of the following options, then press SELECT to select it.

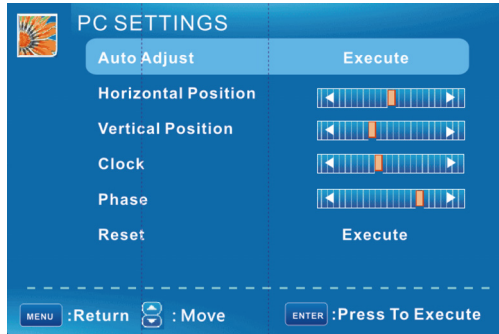

Auto Adjust

Automatically adjust Clock, Phase, H-Position and V-Position settings.

In order to get a good result, you should open a "filling the screen" picture before executing Auto Adjust.

H.Position

Shift the screen slightly to left or right.



V.Position

Shift the screen slightly up or down.

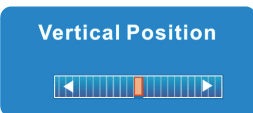

Clock

Adjust the DB15 picture signal sampling clock rate.

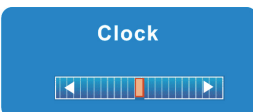

Phase

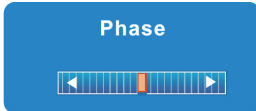

Adjust the DB15 picture signal sampling phase. It maybe affect the definition. Wrong value maybe result the interference.



Reset

Reset the parameters of current menu to default value.

Adjusting VGA Settings

- 1 Use the ◀ / ▶ keys to select **VGA Settings** and press .
- 2 Press the ◀ / ▶ keys on the remote control to select the desired option.
- 3 Press  to save and exit the screen.



Color Temperature

Use Color temperature to adjust the level of white balance in the display.

Three settings are available:

- **Warm:** Pictures appear more reddish.
- **Normal:** Pictures appear more white.
- **Cool:** Pictures appear with a bluish tint.

Adjusting Color Temperature

- 1 Use the ◀ / ▶ keys to select **Color temperature** and press .
- 2 Press the ◀ / ▶ keys on the remote control to select the desired option.
- 3 Press  to save and exit the screen.

Advanced Picture Settings

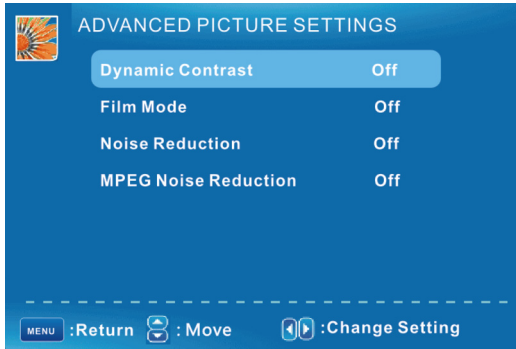

- **Dynamic Contrast** (Off/On)

The system will adjust the luminance curve by analyzing the picture content dynamically.

- **Film Mode** (Off/On)

For the 2:2 or 3:2 format signal of cinema, enable special pixel process to reduce the flick of moving area.

- **Noise Reduction** (Off/On)

You can clear up analog TV signal by reducing the dot noise. This feature is not available at VGA or Media source.

- **MPEG Noise Reduction** (Off/On)

Similar with the Noise Reduction, you can set to reduce the block noise.

SOUND

Use the Sound sub-menus to configure the sound quality.

Press  on the remote control or **MENU** on the control panel to display the setup menu screen then select **Sound** to display the Sound sub-menu. The following options are available: Sound Settings, Analog Sound, Digital Sound, Digital Audio Output, Equalizer Settings, and SRS TruSurround Settings.



Sound Settings

Adjust the picture quality including sound mode, bass, treble, balance.

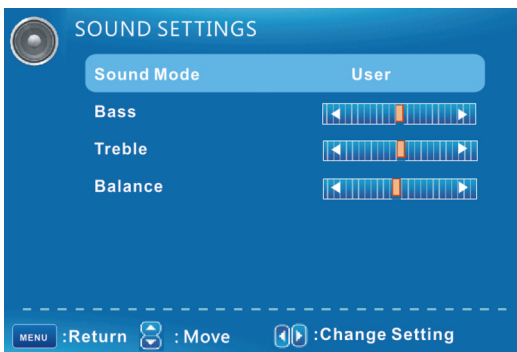

Sound mode

Use this sub-menu to select one of four preset view options optimized for different listening conditions.

The following options are available:



- **Standard:** Select for standard picture.
- **Soft:** Select for a finely detailed picture.
- **User:** Select for standard picture.
- **Dynamic:** Select for enhanced picture contrast and sharpness.

Bass

Use Bass to calibrate low-pitched sounds.

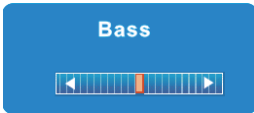
Adjusting Bass





- 1 Use the ◀ / ▶ keys to select **Bass** and press .
- 2 Press the ◀ / ▶ keys on the remote control to adjust the Bass level.
- 3 Press  to save and exit the screen.

Treble

Use Treble to calibrate high-pitched sounds.

Adjusting Treble





- 1 Use the ◀ / ▶ keys to select **Treble** and press .
- 2 Press the ◀ / ▶ keys on the remote control to adjust the Treble level.
- 3 Press  to save and exit the screen.

Balance

Use Balance to adjust the sound balance between the L/R speakers.

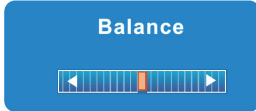
Adjusting Balance



- 1 Use the ◀ / ▶ keys to select **Balance** and press .
- 2 Press the ◀ / ▶ keys on the remote control to adjust the Balance level.
- 3 Press  to save and exit the screen.

Analog Sound (SAP/Stereo/Mono)

Available at analog TV channels.

Set the preferred sound track of analog channels. Stereo and SAP exist on some channels. Generally SAP is a second language sound or help the people with hearing impair.

Digital Sound (English/French/Spanish)

Available at digital TV channels.

Set the preferred sound track of digital channels. French and Spanish exist on some channels.

Digital Audio Output (PCM/Raw/Off)

Set the audio output type of coax or optical terminal. Raw means output the original format of audio stream. PCM can be matched with most AV amplifiers.

Equalizer Settings

Use this sub-menu to select one of four preset audio options optimized for different sounding conditions.

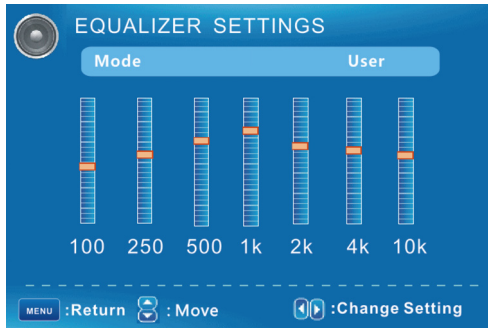

The following options are available:

- **Rock:** Sets the equalizer to the Rock mode.
- **Pop:** Sets the equalizer to the Pop mode.
- **Jazz:** Sets the equalizer to the Jazz mode.
- **User:** Uses the customized settings.

SRS Trusurround Settings

Use this sub-menu to set the sound effects.

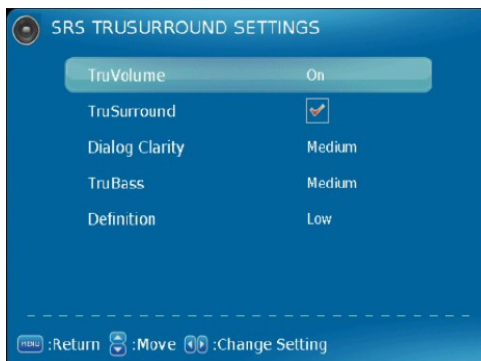

CHANNEL

Use the Channel sub-menus to configure the channel.

Press  on the remote control or **MENU** on the control panel to display the setup menu screen then select **Channel** to display the Channel sub-menu. The following options are available: Channel List, Favorite List, Channel Settings, Signal Type, Auto Channel Search.

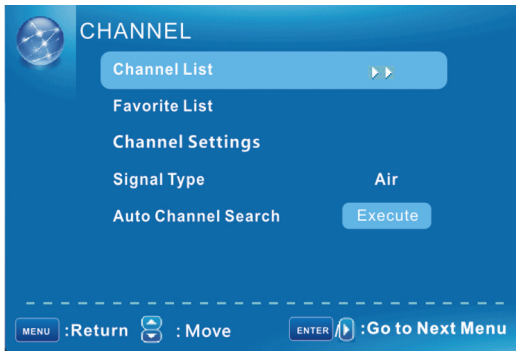

NOTE: The menu is available only at TV source.

Channel List

You can view all the channels and choose one quickly.



"ABC": Label of the Channel

Favorite List

All of you favorite channels are listed in this menu, and you can choose them quickly.



Channel Setting

Set the favorite channels, skipped channels, label of channels.



- **Skip:** Set the channel to be skipped when using CH+/CH- to view channels.
- **Favorite:** Set the channel to your favorite list.
- **Label:** Rename label of the channel.

Change the settings

- **Skip & Favorite**

Press ▲ / ▼ to select the channel you want to set.

Press ◀ / ▶ to highlight corresponding item, and press SELECT to set or cancel.

- **Label**

Press ▲ / ▼ to select the channel and SELECT to enter the edit state.

Press ▲ / ▼ to select the character, press ◀ / ▶ to move the cursor. Total seven letters.

Signal Type

Set to Air or Cable according to your antenna source. When set to Air, TV can catch 8VSB broadcasting signal. When set to Cable, TV can catch analog and clear 64QAM/256QAM broadcasting signal.

Auto Channel Search

Select Auto Channel Search and press **ENT**. Two options are available:

- **Cable:** Choose this setting if you are receiving TV channels with a CATV (cable TV).
- **AIR:** Choose this setting if you are receiving TV channels with an antenna (over the air).

Auto Search automatically creates a list of receivable channels for the selected source.

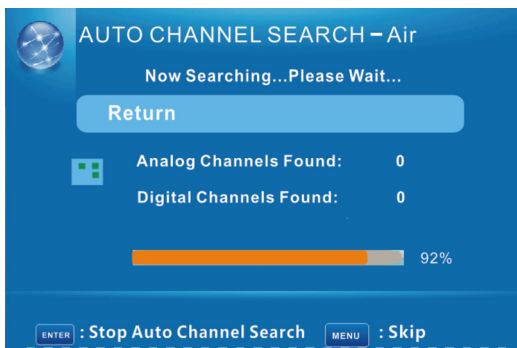

PARENTAL CONTROL

Use the Channel sub-menus to configure the parental control.

Press  on the remote control or **MENU** on the control panel to display the setup menu screen then select **Parental Control** to display the Parental Control sub-menu. The following options are available: Lock Parental Control, V-CHIP, Change Password, Keypad Lock, Source Lock.



Lock Parental Control

The following items are only available if the password input is correct.

V-CHIP

- **US V-Chip**

Rating system used at USA.

- **TV Rating:** Use this sub-menu to customize US TV Rating programs.



| Rating | Description |
|--------|--|
| TV-Y | Suitable for young children. |
| TV-Y7 | May not be suitable for children under 7. |
| TV-G | Suitable for all audiences. |
| TV-PG | Parental guidance suggested. |
| TV-14 | Parental guidance suggested for children under 14. |
| TV-MA | Suitable for mature audiences only; may be unsuitable for children under 17. |
| FV | Fantasy violence, combative situations. |
| D | Suggestive dialogue. |
| L | L Coarse language. |
| S | Sexual situations. |
| V | Violence. |

- **Movie Rating:** Use this sub-menu to select the ratings of allowable movies.



| Rating | Description |
|--------|---|
| G | Contains nothing most parents will consider offensive for even their youngest children to see or hear; suitable for young children. |
| PG | May contain some material parents might not like to expose to their young children-material that will clearly need to be examined or inquired about before children are allowed to view the film. |
| PG-13 | May contain some scenes of drug use; use of one of the harsher sexually-derived words may be heard. May be inappropriate for preteens. |

| Rating | Description |
|--------|---|
| R | May contain some adult material. Parents are urged to learn more about the film before letting their children view it. |
| NC-17 | May contain explicit sex scenes, an accumulation of sexually-oriented language, and/or scenes of excessive violence. Suitable for adult audiences only. Rating does not signify that the film is obscene or pornographic. |
| X | Contains extreme violence or explicit sex; suitable for adult audiences only. |

• **Canada V-Chip**

Rating system used at Canada.

- **Canada English:** Use this sub-menu to select the classification categories (based on Canadian ratings) of allowable TV programs and movies.

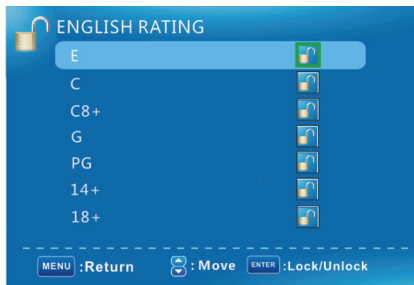

| Rating | Description |
|--------|---|
| E | Exempt shows |
| C | Suitable for viewing by children of all ages. |
| C8+ | Not suitable for children under 8 years of age. |
| G | Suitable for general audiences. |
| PG | Parental guidance advised. |
| 14+ | Suitable for people 14 years of age or older. |
| 18+ | Suitable for people 18 years of age or older. |

- **Canada French:** Use this sub-menu to select the ratings of allowable TV programs and movies. These ratings are based on the classification categories determined by La Régie du cinéma du Québec.



| Rating | Description |
|---------|---|
| E | Exempt shows |
| G | For general audiences. |
| 8 ans + | Not suitable for children under 8 years of age. |
| 13 ans+ | Not suitable for persons under 13 years of age. |
| 16 ans+ | Not suitable for persons under 16 years of age. |
| 18 ans+ | Not suitable for persons under 18 years of age. |

- **Block UnRated Show**

Control whether lock the program that have not any valid rating flag.

- **Downloadable Rating**

Control the RRT5 setting which are valid only at some digital cable channels.

- **Clear Downloadable Data**



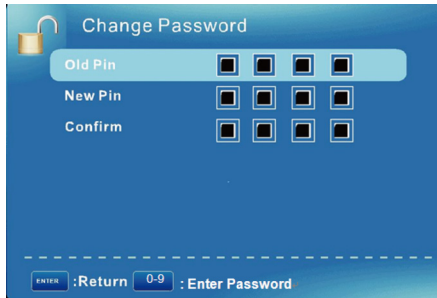

Select to clear the previous downloadable rating data.

Change Password

Change Password allows you to change your current password.



Changing Password

- 1 Use the ◀ / ▶ keys to select **Change Password** and press .
- 2 Use the Channel keys to enter the current password and press .
- 3 Use the Channel keys to enter the new password and press .
- 4 Use the Channel keys to enter the new password again for confirmation and press .
- 5 Press  to save and exit the screen.

Source Lock

Press ▲ / ▼ to select the source you want to lock, then press SELECT to set it to lock. If anyone want to use this source, the password is needed.

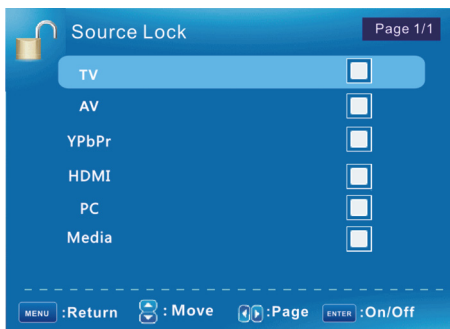

SETUP

Use the Settings sub-menus to configure the LED TV operational setup and view the current firmware version.

Press  on the remote control or **MENU** on the control panel to display the setup menu screen then select **Setup** to display the Settings sub-menu. The following options are available: Closed Captions, Menu Language, Clock, OSD Timer, Power Light.

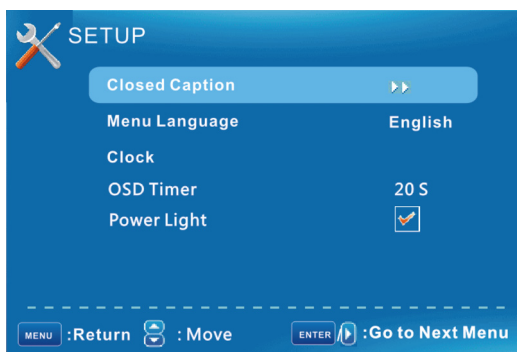

Closed Captions

Use Closed Captions to configure the settings for closed captioning in TV programs.

- **Caption Display**

Display or hide the CC.

- **Analog Caption Type**

Select from below closed-caption modes for analog programs.

CC1,2,3,4: Displays corresponding caption channel of a analog program. (Usually be set to CC1 for most programs).

Text1,2,3,4: Displays corresponding text service channel of a analog program.

- **Digital Caption Type**

Applies only to digital channels with closed caption.

Service1,2,3,4,5,6: These are different service data channels.

- **Digital CC Preset** (Default/Custom)
If set to Custom, Digital CC Style is available.

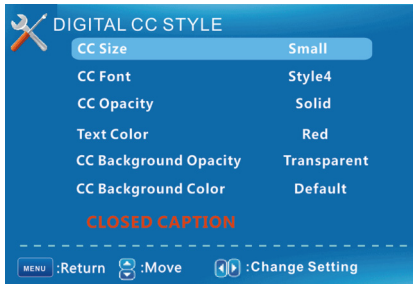

The following options are available:

- **Closed Captions:** Can be set to **ON** or **OFF**.
- **Analog Type:** Can be set to **CC1, CC2, CC3, CC4, T1, T2, T3, or T4**.
- **Digital Type:** Can be set to **CS1, CS2, CS3, CS4, CS5, or CS6**.
- **CC Size:** Can be set to **As Broadcaster, Small, Medium, or Large**.
- **CC Font:** Can be set to **As Broadcaster, Style 1, Style 2, Style 3, Style 4, Style 5, Style 6, or Style 7**.
- **CC Opacity:** Can be set to **As Broadcaster, Solid, Translucent, Transparent, or Flashing**.
- **Text Color:** Can be set to **As Broadcaster, Black, White, Green, Blue, Red, Cyan, Yellow, or Magenta**.
- **CC Background Opacity:** Can be set to **As Broadcaster, Solid, Translucent, Transparent, or Flashing**.
- **CC Background Color:** Can be set to **As Broadcaster, Black, White, Green, Blue, Red, Cyan, Yellow, or Magenta**.



Adjusting Closed Captions Settings

- 1 Use the ◀ / ▶ keys to select **Closed Captions** and press **↵**.
- 2 Use the ▲ / ▼ keys to select the desired Closed Captions option.
- 3 Use the ◀ / ▶ keys to adjust the value.
- 4 Press **☰** to save and exit the screen.

Menu Language

Use Menu Language to select the language to display on the screen: English, French, or Spanish.

Adjusting Menu Language

- 1 Use the ◀ / ▶ keys to select **Menu Language** and press .
- 2 Press the ◀ / ▶ keys on the remote control to select **English, French** or **Spanish**.
- 3 Press  to save and exit the screen.

Clock

Set the Time Zone, Auto Clock, Setup Time, Day of Week or Daylight Saving Time.

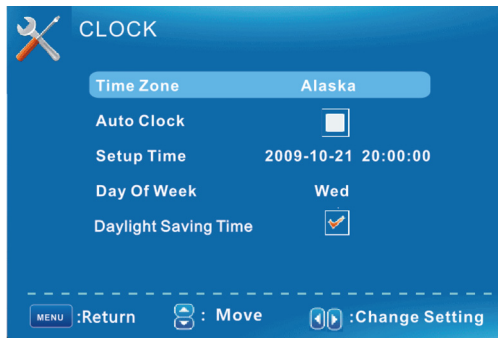

- **Time Zone**

Hawaii/Alaska/Pacific/Central/Mountain/Eastern/Samoa/Newfoundland/Atlantic

- **Auto Clock**

If set it to ON , the TV will sync the local clock according to the DTV broadcasting time automatically. Otherwise you can set the time manually.

- **Setup Time**

Set Auto Clock to Off, then you can set the time manually .

NOTE: In the case of loss of power, the clock setting will be lost.

- **Day of Week**

The TV will calculate current day of week according to the time.



- **Daylight Saving Time**

When Auto Clock set to ON, this item is available to enable daylight saving option or not.

OSD Timer

Use OSD Timeout to adjust the OSD duration on the screen: 10 sec, 20 sec, or 30 sec.



Adjusting OSD Timer

- 1 Use the ◀ / ▶ keys to select **OSD Timer** and press .
- 2 Press the ◀ / ▶ keys on the remote control to select **10 sec**, **20 sec**, or **30 sec**.
- 3 Press  to save and exit the screen.

Power Light

Set to select power light.

Adjusting Power Light

- 1 Use the ◀ / ▶ keys to select Power Light and press .
- 2 Press the ◀ / ▶ keys on the remote control to select **ON** or **OFF**.
- 3 Press  to save and exit the screen.

OTHERS



Blue Back

Set the screen background color blue or not when no valid signal input. When analog TV input and has no signal, snow noise will display if this option is cleared.

No Signal Power Off

If it is set, TV will automatically enter standby after 10 minutes without signal input.

No Operation Power Off

If it is set, TV will automatically enter standby after 3 hours without any operation.

All Reset

When you highlight the item, the system will note you that “Attention! If [All Reset] was executed, TV system is reset” A and if you are sure to reset, press SELECT to reset.

WALL MOUNT OPTION

The LED TV has been fitted with VESA FPMPMI compliant mounting holes. These 200 x 100 mm mounting holes allow the unit to be mounted on a wall. Use the four M4 x L10 mm screws to wall mount the LED TV.

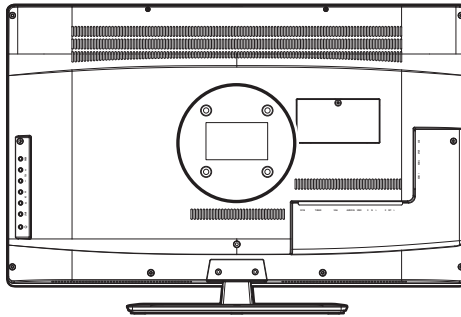

WALL MOUNT INSTALLATION REMINDERS

- Remove the LED TV base first before mounting the unit on a wall.
- It is the user's responsibility to use a UL listed wall mount unit rated to support the weight of this LED TV.
- Please consult qualified contractors for wall mount installation.

CAUTION:

The incomplete or improper mounting of this unit to a wall may cause it to fall down resulting to property damage and/or potentially serious injury.

TROUBLESHOOTING

| Problem | Corrective Action |
|---|---|
| No power | <ul style="list-style-type: none"> • Make sure the power indicator is illuminated blue. • Make sure the power cord is securely connected to the AC-in jack and is plugged into a functional AC outlet. You may want to plug in another electrical device to the power outlet to verify that it is supplying the proper voltage. |
| Power is suddenly turned off. | Make sure the sleep timer is turned off. |
| Remote control does not work. | <ul style="list-style-type: none"> • Press only one button at a time. • Make sure the batteries are properly inserted. • The batteries may already be drained out. Replace batteries with new ones. |
| Remote control code cannot be detected by a universal remote. | <ul style="list-style-type: none"> • Purchase a separate learning remote control. • Go to www.wde.com for a list of remote codes. |
| No picture | <ul style="list-style-type: none"> • Make sure the video input cable is properly connected to the correct terminal, and that the correct input mode is enabled. To illustrate, when a VGA cable is connected to display a computer screen, the VGA input mode must be enabled. • Verify that the antenna is properly connected and that the preferred channel is enabled in the channel list. Press and select Channels/Channel List. • Adjust the display settings. |

| Problem | Corrective Action |
|--|---|
| No picture or the No Signal message appears when a VGA cable is connected. | <ul style="list-style-type: none"> • Make sure the VGA cable is properly connected to the LED TV's VGA port. • Decrease the video resolution setting on the computer and try again. • Adjust the display settings. |
| Picture is cut off or appear in a sidebar screen. | Press ⏏ to adjust the Aspect ratio. |
| Poor image quality in TV mode (cutoff picture, snowy images). | <ul style="list-style-type: none"> • Check your antenna connection. If necessary, rotate the antenna and wait up to ten seconds for a signal. • Reduce signal splitters and excessively long cables. • Replace poor antenna cables and/or connectors to improve signal quality. • Press ⏏ to adjust the Aspect ratio. • Adjust the Noise Reduction setting in Picture menu. • In HDMI mode, make sure the external device is compatible with the LED TV. |
| Wrong, abnormal or missing colors | <ul style="list-style-type: none"> • If any colors (red, green or blue) are missing, check the video cable to make sure it is securely connected. Loose or broken pins in the cable connector could cause an improper connection. • Adjust the Hue, Saturation and Color Temperature settings in Picture menu. • Connect the TV to another computer and check if the problem is with the computer screen. |

| Problem | Corrective Action |
|--|---|
| No sound | <ul style="list-style-type: none"> • Make sure the audio input cable is properly connected to the correct terminal, and that the correct input mode is enabled. • The volume may be muted, press or Vol+ key to turn on the volume. • Adjust the Bass, Treble, and Balance settings in Audio menu. • If you are using the TV speakers, make sure the TV Speakers option is set to On in Audio menu. • If you are using an external audio device, press and select Audio to make sure the TV Speakers option is set to Off in Audio menu. |
| <p>NOTES: If the problem condition persists even after performing the recommended corrective actions, contact us by:</p> <ul style="list-style-type: none"> • Logging on to www.wde.com • Contacting the Westinghouse Customer Service at (800) 701-0680 or e-mail us at service@wde.com | |

SPECIFICATIONS

| Item | Specification | |
|------------------------------------|--|---------------------------|
| Model Name | EW32S5UW | |
| Panel | Active Area (Diagonal, mm) | 697.685 (H) x 392.256 (V) |
| | Resolution | 1366 (H) x 768 (V) |
| | Contrast Ratio (min) | 3000:1 |
| | Response Time (min) | 6.5ms(g-g) |
| | Aspect Ratio | 1.77 (16:9) |
| | Display color | 16.7M |
| Audio/Video Input/Output Terminals | <ul style="list-style-type: none"> • HDMI x2 • AV with R/L Audio x1 • VGA with 3.5 mm mini jack x1 • SPDIF Out x1 • USB for service x1 • Tuner x1 • R/L Audio Line Out X1 | |
| Speaker Out | 2X3W (2 channels) | |
| AV Timing | 480i/p, 720p, 1080i/p | |
| VGA Timing | 640 x 400 @ 60Hz, 640 x 480 @ 75Hz, 800 x 600 @ 60Hz, 800 x 600 @ 75Hz, 1024 x 768 @ 60Hz, 1024 x 768 @ 75Hz, 1366 x 768 @ 60Hz | |
| Power Consumption (Watts) | ≤ 65W (@ 19V DC) | |
| Power Consumption (Standby, Watts) | <1W | |

SPECIFICATIONS

| Item | Specification | |
|-------------------------|--------------------|--|
| Physical Specifications | Dimensions (WxHxD) | With stand: 749.84mm x 503.57mm x 159.8mm Without stand: 749.84mm x 458.85mm x 52mm |
| | Weight (Net) | 6.19Kg |
| | Weight (Gross) | 8.6Kg |

NOTES:

- These product specifications are subject to change without user notification.
- Do not set your computer graphics card to exceed the unit's refresh rates; doing so may cause damage to the LED TV.



www.westinghousedigital.com

┌
S/N: _____
└

Westinghouse Digital, LLC
Orange, CA

SE-UM-3202-1201